

User Manual

EzLogger







Ver 03

Table of Contents

1、 Symbols	01
2、 Safety	02
3、 Installation	03
3.1 Unpacking	03
3.2 Appearance and Size	04
3.3 Equipment Installation	04
3.4 Electrical Connection	06
4、 Indicator Lights ..	20
5、 Operation with Ripple Control Receiver (RCR) . . .	21
5.1 Connection with RCR	21
5.2 Operation with RCR	22
6、 Reset and Reload	23
7、 Operate with EzExplorer	24
7.1 New EzLogger	24
7.2 Edit EzLogger	27
7.3 Delete EzLogger	29
7.4 Memory Status	31
7.5 View Property	33
7.6 Summary	35
7.7 Set date Collect Period	37
8、 Technical Parameters	40
8.1 Operation Conditions	40
8.2 Operation Limitation	40
8.3 Data Storage	41
9、 Certificates	41
10、 Warranty	42
10.1 Warranty Period	42

10.2 Warranty Card	42
10.3 Warranty Conditions	42
10.4 Scope of Warranty	43
11、 Contact	44

1、 Symbols

	Caution! - Failure to observe a warning indicated in this manual may result injury.
	Product should not be disposed as household waste.
	This side up; the package must always be transported, handled and stored in such a way that the arrows always point upwards.
	Components of the product can be recycled.
	Fragile; the package/product should be handled carefully and never be tipped over or slung.
	Keep dry; the package/product must be protected from excessive humidity and must be stored under cover.
	CE Mark

2、 Safety

The EzLogger of Jiangsu GoodWe Power Supply Technology Co. Ltd. (hereinafter referred to as GoodWe) strictly conforms to related safety rules in design and test. Safety regulations relevant to the location shall be followed during installation, commissioning, operation and maintenance. Improper operation may cause serious injury, electric shock and/or damage to equipment and property.









- ▶ Ensure children are kept away from EzLogger.
- ▶ Do not open the front cover of the EzLogger. Apart from performing work at the wiring terminal (as instructed in this manual), touching or changing components without authorization may cause injury to people, damage to EzLogger and annulment of the warranty.
- ▶ Static electricity may damage electronic components. Appropriate methods must be adopted to prevent such damage to the EzLogger; otherwise the EzLogger may be damaged and the warranty annulled.

3、Installation

3.1 Unpacking

When you receive the GoodWe EzLogger, please check for external damage to the EzLogger and any accessories. Please also check that the followings are included:

EzLogger.	1	Power Adapter	1
Micro SD Card	1	Fixing Bracket	2
Screw M3*8	4	Mini USB Cable.	1
User Manual	1	Warranty Card.....	1
Flash Disk	1	Connector.....	1

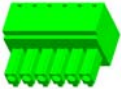
 <p>EzLogger</p>	 <p>Power Adapter</p>	 <p>Fixing Bracket</p>	 <p>Screw M3*8</p>
 <p>Mini USB Cable</p>	 <p>Micro SD Card</p>	 <p>User Manual</p>	 <p>Warranty Card</p>
 <p>Flash Disk</p>	 <p>Connector</p>		

3.2 Appearance and Size

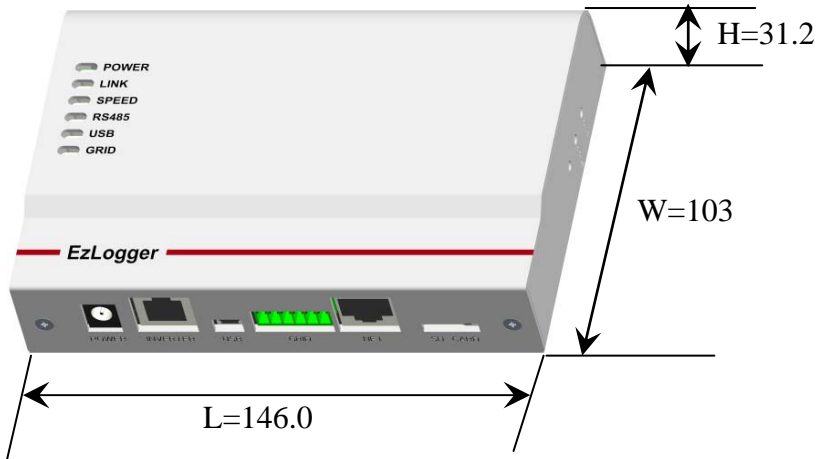

Figure 3.2.1

3.3 Equipment Installation

3.3.1 Selecting the installation position

The following must be considered when selecting the best location for an EzLogger:

- ▶ Indoor use only.
- ▶ The mount and installation method must be suitable for the EzLogger's weight and dimensions.
- ▶ The location must be well ventilated and sheltered from direct sunlight.

3.3.2 Mounting Procedure

Step 1 : Assemble EzLogger and Fixing Bracket as shown in the Graph 3.3.2-1, and tighten them by Screws M3*8 in the accessory bag.

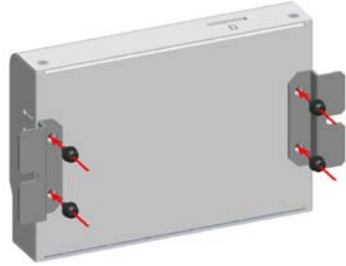

Figure 3.3.2-1

Step 2 : Tighten EzLogger by Screws $\phi 4*12$. Installation dimensions are shown in the Graph 3.3.2-2.

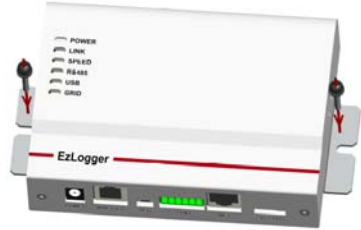

Figure 3.3.2-2

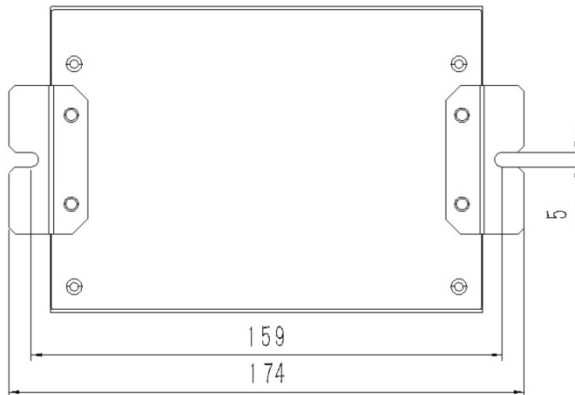

Figure 3.3.2-3 Size of installation plate

3.4 Electrical Connection

3.4.1 Interface Instruction

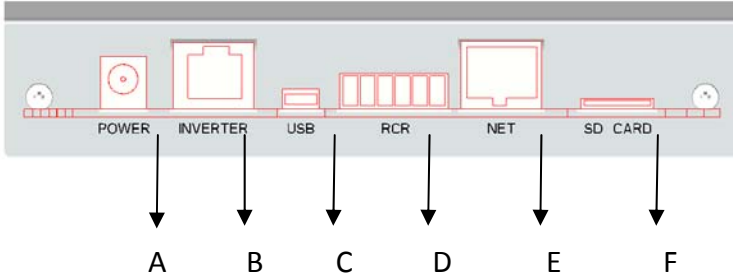



Figure 3.4.1

A	Adapter Socket
B	RS485 RJ45 Socket (connects to inverter)
C	USB port Socket
D	6pin Terminal Socket, Refer to Table 3.3
E	LAN RJ45 Socket (connects to network)
F	Micro SD Card Socket

Table 3.4.1

Notice: Unpack the micro SD card and insert it to the socket (F)

	Please do not mix interface B and E up which will lead to damage to EzLogger!
---	--

3.4.2 Installation Procedure

Step1: First of all, make up cables

NOTICE: In order to implement waterproof, the cables should be made up by hand strictly obey the guidance in manual of inverter.

The line sequence of both plugs of RS485 cable should be made up same as shown in Fig3.4.2.1.

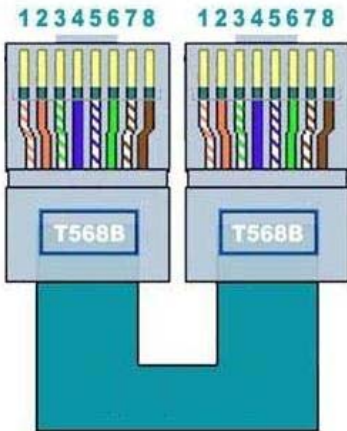

Fig3.4.2.1 Line sequence

The line sequence in both RJ45 plugs should obey TIA/EIA-568B criterion strictly, from 1 to 8 as below:

Line	Color	Line	Color
1	Orange & White	5	Blue & White
2	Orange	6	Green
3	Green & White	7	Brown & White
4	Blue	8	Brown

Besides that, each cable should be tested by LAN cable tester to ensure the cable is OK. These cables will be used to connect not only EzLogger and inverter but also inverter and inverter.

Step2: Check the cable daisy chain

The whole system should be made up as shown in below Fig3.4.2.2, in which the laptop is only used for debug.



Fig3.4.2.2. Whole system connection diagram

Before complete the whole connection, it should be tested as below:

Test the connection from plug 1a to plug (N+1)b as shown in

Fig3.4.2.3. If everything is ok, the LAN cable tester will tell the line 3/6/7/8 is OK. **Neglect the status of line 1/2/4/5** because the line1 is shorted to line2 and line4 is shorted to line5 in inverter.

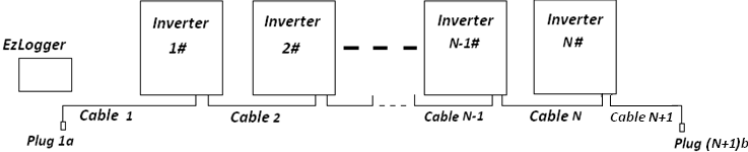

Fig3.4.2.3. Check the whole RS485 cable connection

If the line 3/6/7/8 is not ok, please pull out the plug Nb from inverter N#, and test the connection from plug1a to plug Nb, as shown in Fig3.4.2.4.

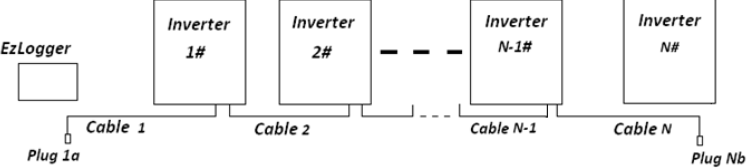

Fig3.4.2.4. Check the connection between 1a and Nb

If the test result is ok, it means there is something wrong with inverter N#. First re-check cable N+1 using LAN cable tester and make sure it is OK and insert the plug back into inverter N#. Then insert plug Nb into inverter N#, and pull out plug Na from inverter (N-1)# as shown in Fig3.4.2.5. Check and make sure the connection of plugs and sockets is firmly good. Then test the

connection between plug Na and plug (N+1)b. If the connection is OK, insert plug Na into inverter (N-1)#. Then re-test connection from plug 1a to plug (N+1)b and the result will pass.

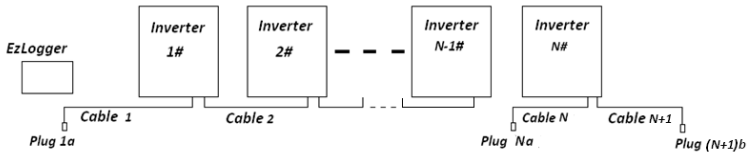

Fig3.4.2.5. Check the connection between Na and (N+1)b

Repeat steps above can find the bug and then fix it one by one until the whole daisy chain connection is ok.

At last pull out cable N+1 from inverter N# and fasten the cover and then insert plug1a to EzLogger.

Step3: Power on the EzLogger and all inverters. Observe the status of LED indicators on top cover of EzLogger.

If everything is OK, it should be like below:

Power Led: always on

If not, check the power supply adaptor of EzLogger.

Speed Led: always on after the LAN cable is connected to the Ethernet network

Link Led: flash frequently after the LAN cable is connected to the Ethernet network

If not, check the connection between EzLogger and exchanger or router.

RS485 Led: flash every 1 minute

If not, it means the communication between EzLogger and inverters is not OK. We need to re-check the connection of the cable daisy chain and confirm the protocol.

3.4.3 Configure EzLogger

A laptop with Ethernet socket is essential for EzLogger configuration.

Step1. Power the EzLogger on with power adaptor

Step2. Using a CAT5 LAN cable connect the laptop with EzLogger directly. Modify the IP address of the laptop to 192.168.1.100 following steps below.



Fig3.4.3.1. Click Start, and click 'Control Panel'

You will get:

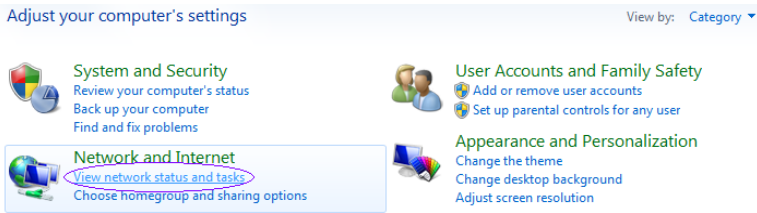

Fig3.4.3.2. Click 'View network status and tasks'

You will get:

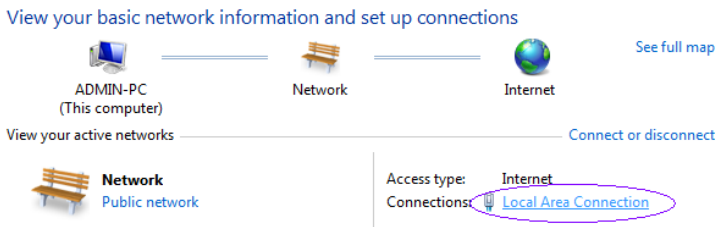

Fig3.4.3.3. Click 'Local Area Connection'

You will get:

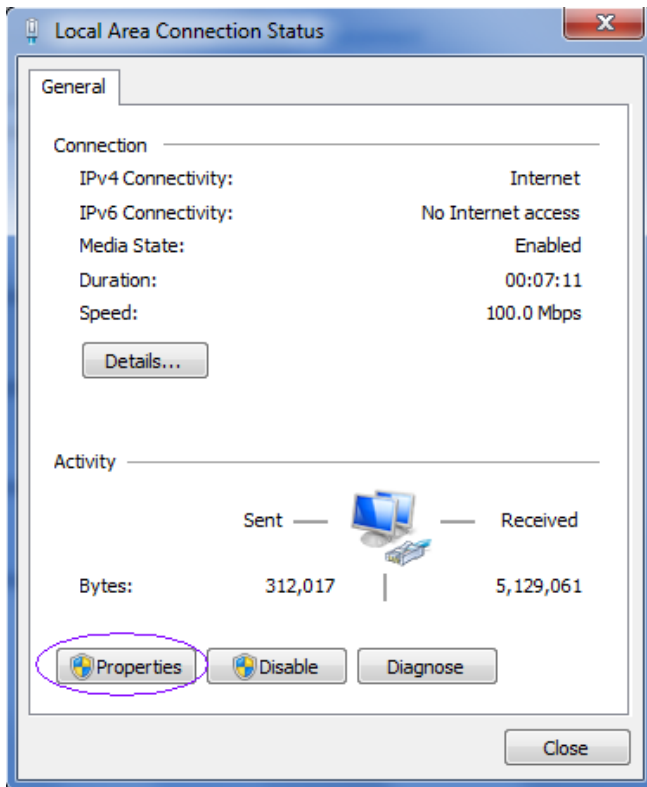

Fig3.4.3.4. click 'Properties' button

You will get:

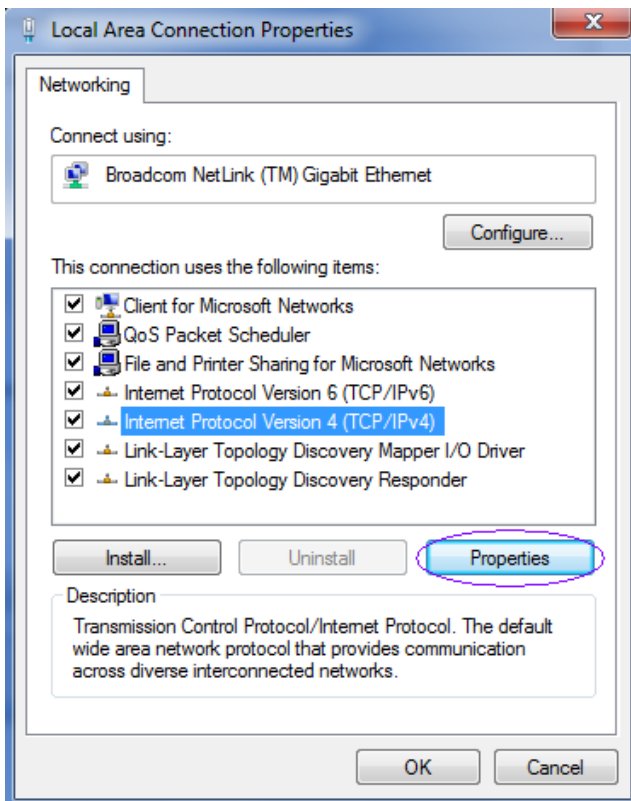

Fig3.4.3.5. Choose 'Internet Protocol' and click 'Properties'

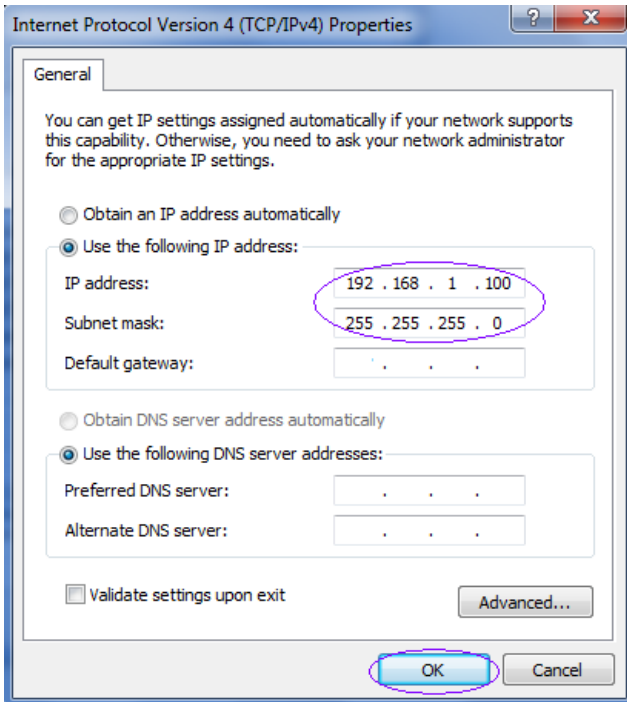

Fig3.4.3.6. Choose 'Use the following IP address' and key the digital in purple circle as above and click 'OK' button

Step4. Run EzConfig.exe that is stored in the flash disk.

If the 'Connection Status' is 'Connect Fail', please check the IP address of your laptop is 192.168.1.100 or not.



Step4.1 Time Configuration

Once EzConfig.exe connects with EzLogger successfully, it will set the system time of the laptop to EzLogger automatically. If there is time difference from local time, you can click 'Set Time' button to set time.

Step4.2 Inverter Information

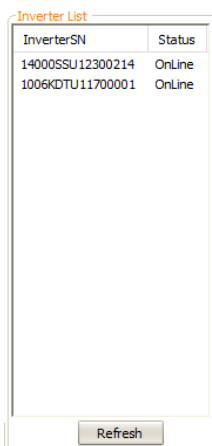

Fig3.4.3.7. Inverter List

After connects, you can click 'Refresh' button to acquire the

inverter list which are communicating with EzLogger well.

Only when each inverter installed in the whole system is online can we finish the debug process.

Step4.3 LAN Parameter Configuration

There are two ways for EzLogger to be allocated IP address. One is static IP address and the other one is automatically.

Click 'DHCP Enable' to enable DHCP function which means the IP address of EzLogger will be allocated from router or switch automatically.



The screenshot shows a 'LAN Configuration' window. At the top left, it says 'LAN Configuration' in orange. To its right is a checked checkbox labeled 'DHCP Enable'. Below this, there are three input fields: 'IP' with the value '192.168.1.100', 'Subnet Mask' with the value '255.255.255.0', and 'Gateway' with the value '192.168.1.1'. A 'Set' button is located at the bottom right of the configuration area.

Fig3.4.3.8

However if it is preferred to use a static IP address for EzLogger, please type the correct IP, Subnet Mask and Gateway, and then click 'Set' button and the LAN configuration will be applied to EzLogger

NOTICE:

Once LAN parameter is modified, the connection between EzLogger and EzConfig will break. If it is needed to connect EzConfig with EzLogger again, you have to reload EzLogger to

factory setting according to 5.

Please DO NOT enable 'ARCF ' or 'Real-Time Data', otherwise it will make EzLogger out of work. (It is reserved for ARCB product.)

Step5. Disconnect EzLogger from the laptop and connect as below.

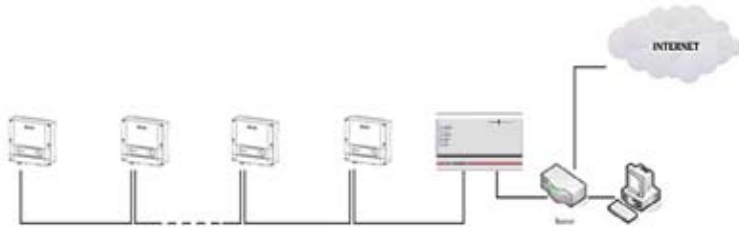

Fig3.4.3.9. Whole system connection diagram

3.4.3 Registration in GoodWe Portal

Browse <http://www.goodwe-power.com>, and click the “Register” button. Select “End User” as user type, and fill in the register table and the registration is completed.

3.4.4 Create PV Station in GoodWe Portal

Fill in the table of the “New Station” web page according to the actual location of your station. In the “Maintain EzLogger”

column, enter the information of the EzLogger including S/N and Check Code, and click “Add” button. Then enter the information of the inverter that is connected with the EzLogger including S/N, Check Code, Type and Description, and click “Add” button.

If you have several inverters connected with EzLogger, you need to enter their information one by one.

Click “Create Station” after you fill in all the information needed, and then everything is OK now. Then switch on the inverters and several minutes later you can view the data of inverter in web portal.

NOTICE: you can find S/N and Check Code on the back side of EzLogger and right side of inverter.

4、Indicator Lights

There are 6 indicator lights on left side of the front cover.

Label	Light On	Light Off	Colour
POWER	Powered on	Powered off	Green
SPEED	Joined to local network	Disconnected from local network	Yellow
RCR	Received command from	No command from RCR	Yellow

Table 4-1

Label	Flickering	Light Off	Colour
LINK	Joined to local network	Disconnected from local network	Yellow
RS485	Communicates with Inverter	Data Interval	Yellow
USB	File Transmission to PC	No File Transmission	Yellow

Table 4-2

5、 Operation with Ripple Control Receiver

The EzLogger can be connected with ripple control receiver (RCR for short afterwards) and executes the command from it.

5.1 Connection with RCR

Pick up the 6-pin terminal plug like below:

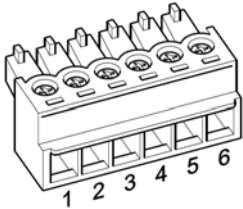

Figure 5.1-1

Pin	Allocation	Description
1	D.IN.1	Level 1(60%)
2	D.IN.2	Level 2(30%)
3	D.IN.3	Level 3(0%)
4	D.IN.4	0.95 Lagging
5	D.IN.5	0.90 Lagging
6	GND	

Table 5.1

Fabricating the cable using the terminal plug and connects with RCR according the description and the type of RCR. Please see below example:

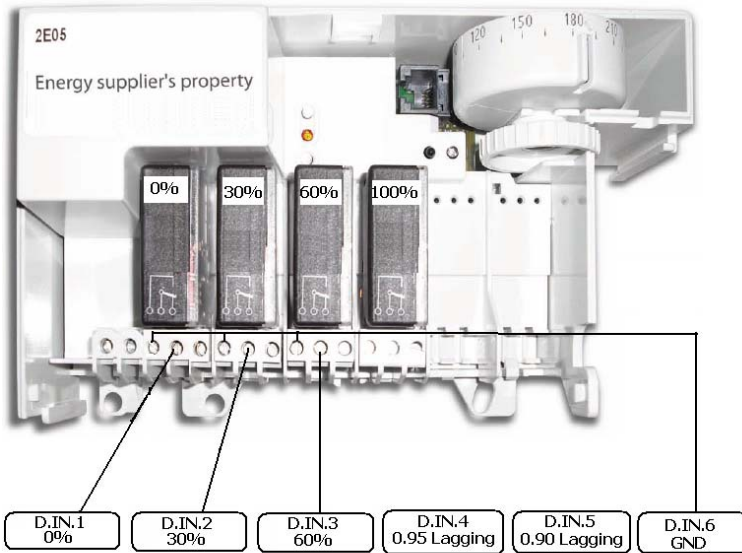

Figure 5.1-2

5.2 Operation with RCR

Keep the connection between EzLogger and RCR stable, and both powered on. The EzLogger will execute the command from RCR automatically.

6、Reset and Reload EzLogger

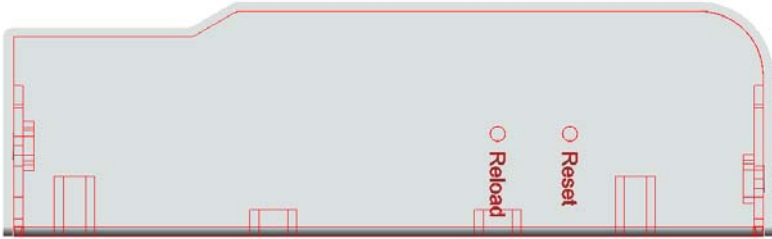

Figure 6

There are two buttons in the right side of EzLogger.

One is the Reset button, press this button to restart the EzLogger .

The reload button is used to reload the default configuration of network parameter of EzLogger. Press this button longer than 3 seconds to the change the EzLogger to default configuration.

Notice: All configurations have to be reset after using reload function.

7、 Operating EzLogger with EzExplorer

7.1 Create a New EzLogger configuration

Click “New EzLogger” in the “EzLogger” drop down menu (or click new EzLogger menu in the EzLogger menu in the menu bar).

See Figure 7.1-1:

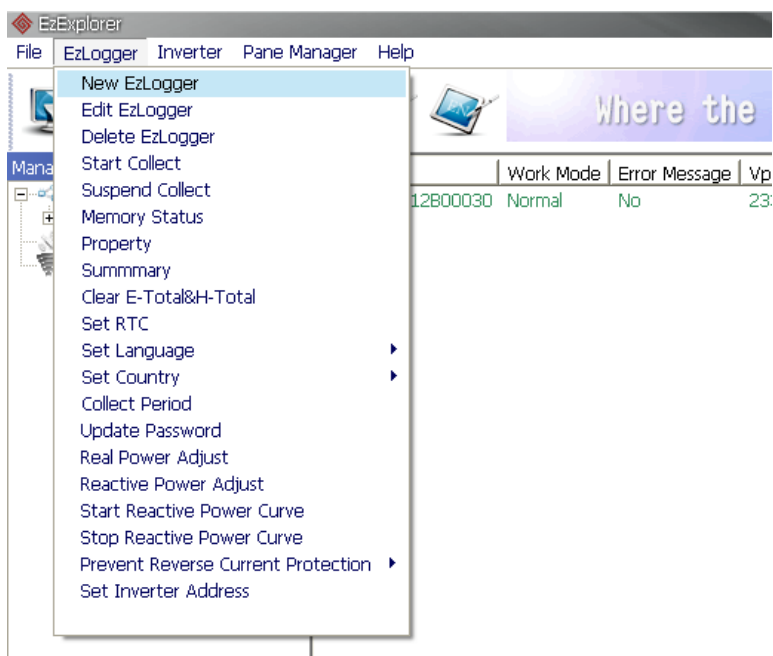

Figure 7.1-1

After click “New EzLogger”, there will be a “New EzLogger” dialog box. See Figure 7.1-2

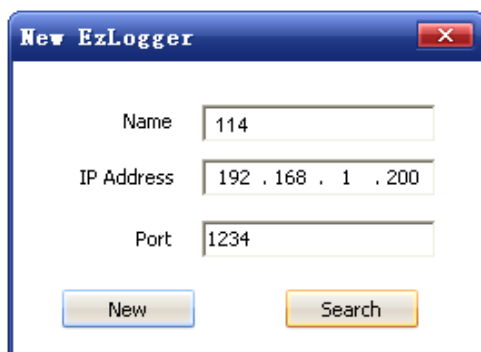

Figure 7.1-2

If the EzLogger is in the same LAN segment with EzExplorer, EzExplorer will search and find it out automatically. Otherwise you need to type the IP address of EzLogger manually. The IP address is that you set to EzLogger in advance via EzConfig, or 192.168.1.200 as factory setting. Or you can click 'Search' button and type in the subnet IP and subnet mask. See Figure 7.1-3

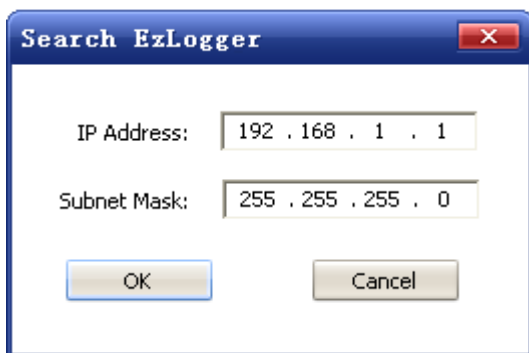

Figure 7.1-3

EzExplorer will search in the LAN segment and find it out automatically. The port is set to 1234 as default which cannot be altered.

Besides, you can name the EzLogger. The name must be comprised of numbers or letters.

Click the OK button in the dialogue box. The icon of the EzLogger will become grey at first. If the EzLogger is connected to the PC, the colour will change to orange. This will indicate that the connection between EzExplorer and the EzLogger has been established. The colour will become blue if there is/are inverter(s) connected to EzLogger. This will indicate that EzExplorer has successfully acquired data from the inverter/s via EzLogger. See Figure 7.1-4.

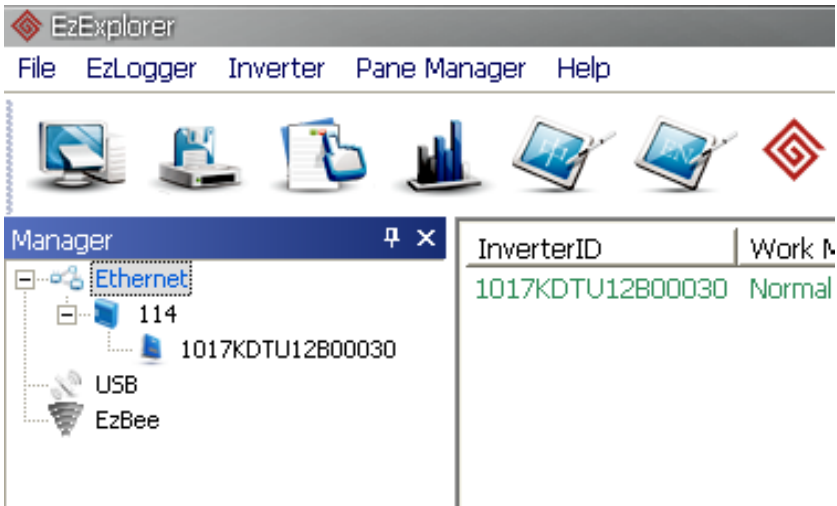

Figure 7.1-4

7.2 Edit the EzLogger

You may need to modify the network parameters such as the IP address, subnet mask and gateway to suit your local network after the EzLogger is connected successfully for first time if you did not configure the parameters via EzConfig.exe in advance.

Note: Please press the reset button which will restart the EzLogger manually and will apply all changes.

Right click one EzLogger icon under the Ethernet icon in the manager area and click the “Edit EzLogger” in the drop down menu (or click “Edit EzLogger” in the EzLogger menu in the

menu bar). See Figure 7.2-1.

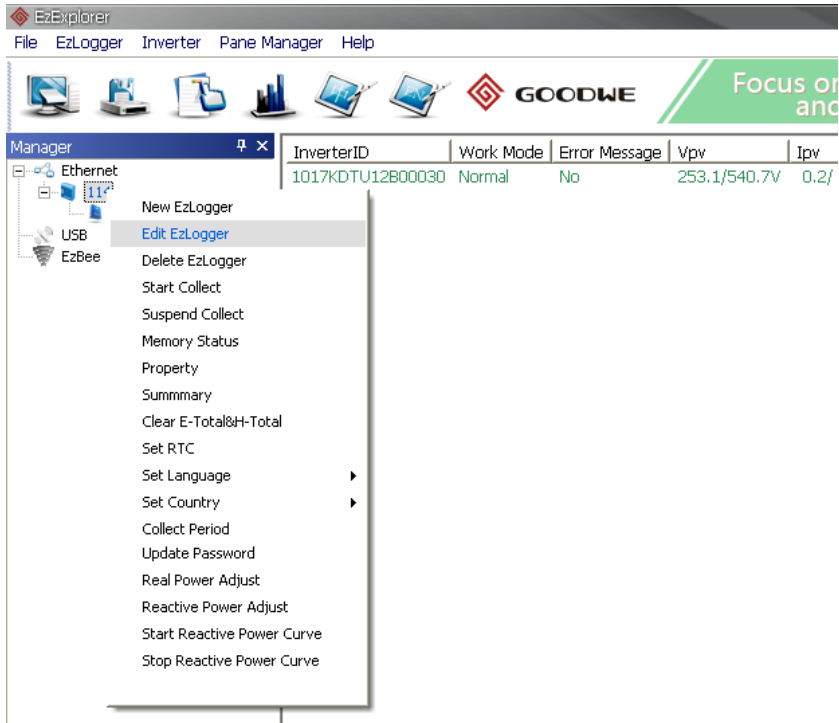

Figure 7.2-1

After clicking the “Edit EzLogger” menu item, an “Edit EzLogger” dialog box will appear. Fill in the correct parameters according to your local network. See Figure 7.2-2.

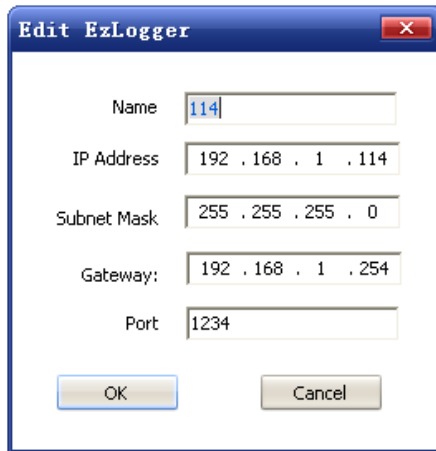

Figure 7.2-2

In the edit EzLogger dialog box, when editing the name, it must comprise numbers or letters.

The IP Address edit box can be changed to comply with your local network segment or if the IP address is in conflict with another device.

Note: Please restart the EzLogger after any changes of LAN parameters.

7.3 Delete EzLogger

Right click an EzLogger icon under the Ethernet icon in the manager area and click the "Delete EzLogger" menu item (or

click the “Delete EzLogger” menu of the EzLogger menu in the menu bar).

See Figure 7.3-1.

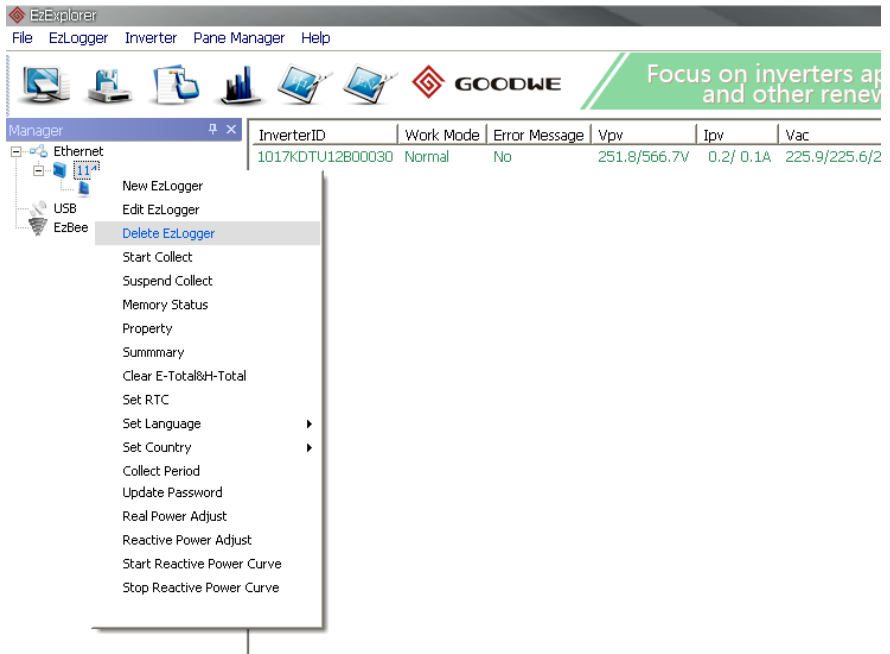

Figure 7.3-1

After clicking on “Delete EzLogger” a pop-up dialogue box "Set Local Password" will prompt the user to provide a password. See Figure 7.3-2.



Figure 7.3-2

Enter the password and click on the “OK” button.

A “Prompt” dialogue box will then appear. See Figure 7.3-3.

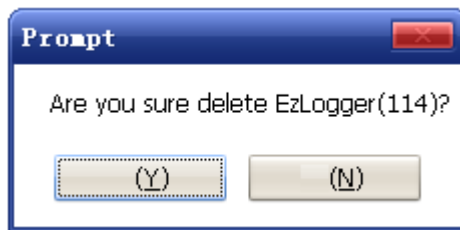

Figure 7.3-3

In the “Prompt” dialog box, click "Y" to delete EzLogger or click “N” to cancel the action.

7.4 Memory Status

Right click an EzLogger icon under the Ethernet icon in the manager area and then click the “Memory Status” menu item (or click the “Memory Status” menu of the EzLogger menu in

the menu bar). You can also click the “Memory Status” button in the toolbar.

See Figure 7.4-1.

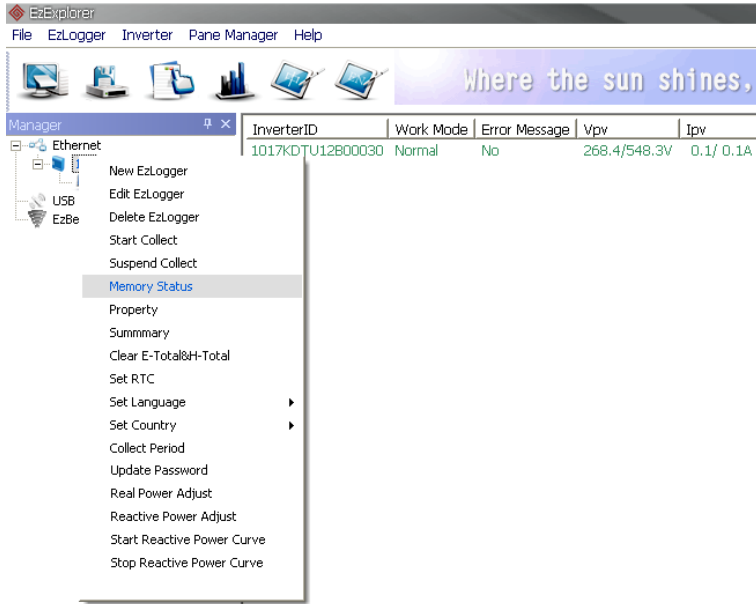

Figure 7.4-1

After clicking the “Memory Status” menu item, a memory status dialog box will appear. See Figure 7.4-2.

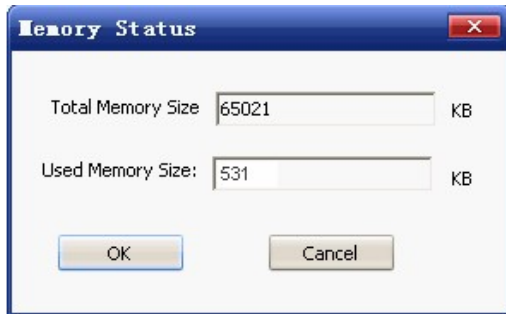

Figure 7.4-2

In the memory status dialog box, two field boxes are available: total memory size and used memory size. So you can view the memory usage of the selected EzLogger.–Both fields are read only and cannot be modified.

7.5 Property

Right click an EzLogger icon under the Ethernet icon in the manager area and click the “Property” menu item (or click the “Property” menu of the EzLogger menu in the menu bar). See Figure 7.5-1.

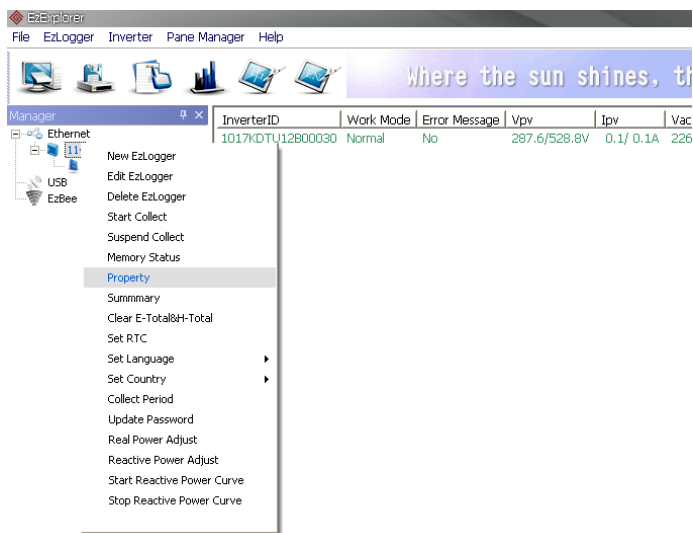

Figure 7.5-1

After clicking the “Property” menu item, a property dialog box can be seen on screen .See Figure 7.5-2.

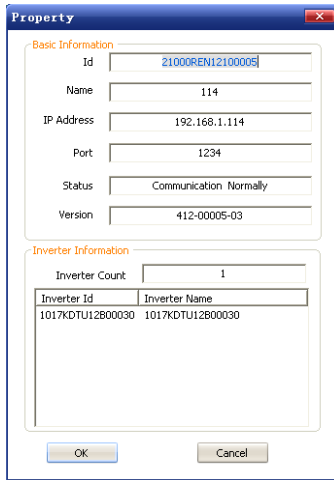

Figure7.5-2

The data in the property dialog box cannot be altered. All fields in the dialogue box will contain data.

7.6 Summary – Power Yield

This function is used to view the power yield by all the inverter/s attached to the selected EzLogger.

Right click an EzLogger icon under the Ethernet icon in the manager area and click the “Summary” menu item (or click the summary menu of EzLogger in the menu bar), and a window will then display a summary. See Figures 7.6-1 & 7.6-2.

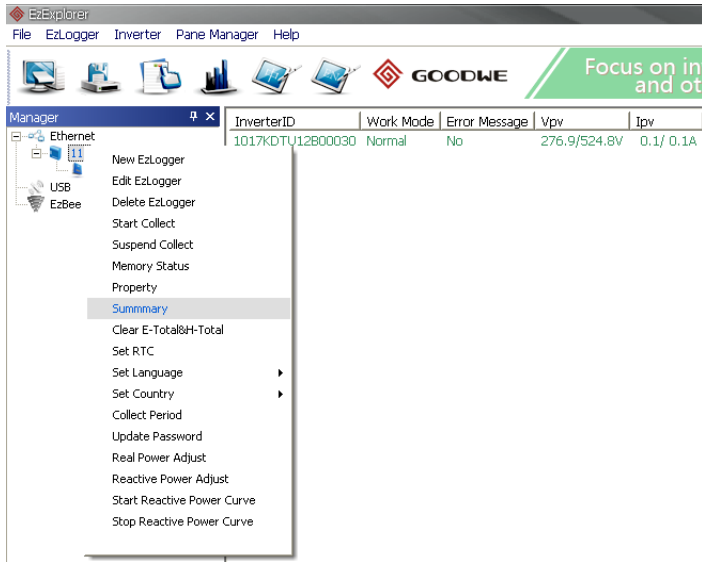

Figure 7.6-1

The default interface of the EzLogger summary is displayed in Figure 7.6-2.

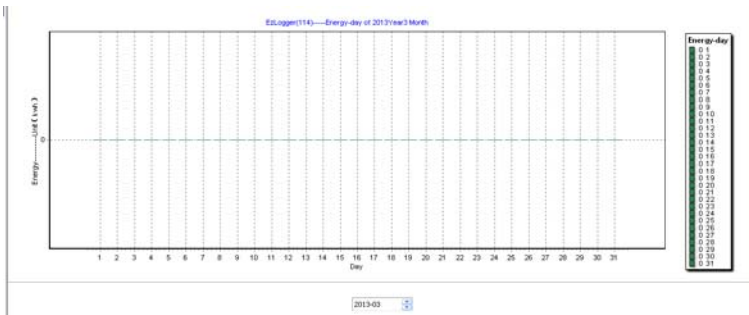

Figure 7.6-2

The EzLogger summary is displayed as three levels: a yield

energy histogram for each day of the month, an energy histogram for each month of the year, and finally a histogram for each and every year.

7.7 Set the data Collect Period

Click the “Collect Period” menu item of the EzLogger menu in the menu bar (or right click the EzLogger icon under the Ethernet icon in the manager panel and click the “Collect Period” menu).

See Figure 7.7-1.

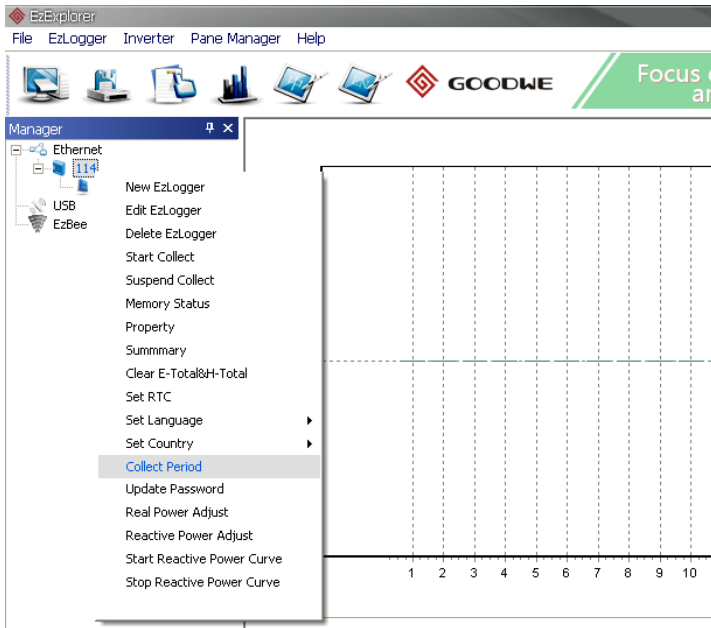

Figure 7.7-1

When the “Collect Period” menu item has been selected, a pop up box “Require Password for Setting” will be available. See Figure 7.7-2.

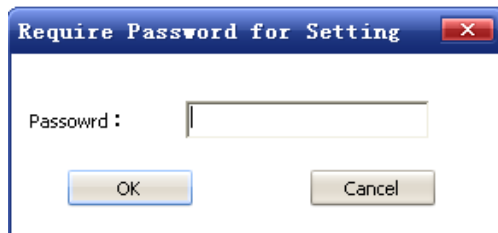

Figure 7.7-2

Then input the password and click the "OK" button. The default password is 123456. Then a further pop-up box will appear "Set Collect Period" See Figure 7.7-3.

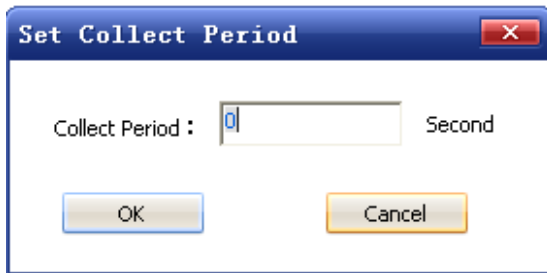

Figure 7.7-3

In the "Set Collect Period" window, input a number higher than 180 and click the "OK" button. A message panel will display the result.

Note: Collect period is the frequency that EzLogger will source data from the inverter/s. E.g. If the collect period is 180 seconds, then EzLogger will request data from the inverter/s every 180 seconds.

8、 Technical Parameters

8.1 Operation Conditions

EzLogger can be installed indoor only; it will cause damage if it runs out of range of following conditions:

Input Voltage	9 VDC
Input Current	500m A
Power Consumption	5 W
Operating Temperature Range	-20~60°C
Humidity Range	0% - 95%

Table 8.1

8.2 Operation Limitation

Communication Interface	Communication Mode	Distance Limitation
RS485	RJ45	MAX. 800 m Cable
USB Port	MiniUSB_B	MAX. 2 m Cable
Net Port	Network	MAX. 100m Cable

Table 8.2

8.3 Data Storage

The data of inverter is storage as csv format files in micro SD card. Its capacity is 2GB which is only available for data of 20 inverters not longer than 3 years. When the space is using up, the oldest data files will be deleted. And you can download the csv file via a micro SD card reader or the USB cable.

9、Certificates



Figure 9

10、 Warranty

10.1 Warranty Period

GoodWe provides a standard warranty of 2 years for EzLogger. Additional provision will be subject to contract.

10.2 Warranty Card

The warranty card and purchase invoice should be properly kept for the product warranty period. Meanwhile, the nameplate on products shall be kept clearly visible. Otherwise GoodWe may reject warranty service or only provide paid service.

10.3 Warranty Conditions

According to the GoodWe product description and instructions, if a device becomes defective within the warranty period, and it is proved that further functional performance is impossible due to a problem with product quality, the device will be, as decided by GoodWe:

- A** Returned to the factory for maintenance; or
- B** Repaired onsite; or

- C Replaced (If the original model is no longer produced, GoodWe will provide a replacement device of equivalent value according to model and age.)

10.4 Scope of Warranty

Warranty is not valid in the following situations:

- ▶ Products or fittings exceed warranty period (excluding any warranty extension agreement signed beforehand).
- ▶ Fault or damage is caused by improper operation or not following the user manual, product instructions, or relevant safety regulations.
- ▶ Insufficient ventilation of the unit.
- ▶ Fault or damage due to improper installation, repair, change or removal by persons who are not authorized by GoodWe.
- ▶ Fault or damage due to unpredictable accidental factors, human errors or force majeure.
- ▶ Fault or damage unrelated to product quality.

11、Contact

If you have any enquiries or technical problems concerning a GoodWe SS series inverter, please contact our customer services.

Address: No.189 Kun Lun Shan Road, Suzhou New District, Jiangsu, China (Jiangsu GoodWe Power Supply Technology Co., Ltd.)

Tel: + 86 512 6239 6771

Fax: + 86 512 6239 7972

E-mail: service@goodwe.com.cn

Website: www.goodwe.com.cn